

## Quick Start Guide

Nexpand Row-Based Cooling

Direct Expansion units

---

# NEXPAND



**Minkels Nexpand DX10 / DX20**

## Contents

1. General.....	3
2. Monitoring & Control.....	5
3. Components.....	8
4. Alarms.....	11

## 1. General

The intention of the Quick Start Guide is threefold:

1. describe the functions of the Direct Expansion (DX) Nexpanse coolers.
2. to provide an overview of the most relevant parameters and alarms.
3. to explain how to configure these parameters and alarms.

For a general overview of the user interface, settings, and the overall structure of the menu's accessible via the display please consult the Software Manual. Only the most common and relevant settings are covered in this Quick Start Guide.

For an overview of the components, service intervals and installation guidelines please consult the User Manual. Throughout this document there shall be references to various documents. With each cooler a set of hard-copy documentation is provided. This is listed here below:

- User Manual
- Software Manual
- Electrical Diagram
- List of parameters
- CE Certificate

### 1. Language setting

With access to the USER menu the language setting can be done. The password for the user menu is 000100 by default. The parameter involved is **A01**.

### 2. Time and date setting

With access to the USER menu the time and date settings can be done. The password for the user menu is 000100 by default. The parameter involved is **A02**. The day, month and year can be set as well as the time in a 24hr schedule. To confirm and store these settings it is necessary to change "update" from NO > YES. It will store the new settings and the value will go back to NO.

### 3. Changing passwords (USER MENU)

With access to the USER menu the password can be changed. The password for the user menu is 000100 by default. The parameter involved is **A08**. The password is a 6-digit number.

### 4. Changing passwords (MAINTENANCE MENU)

With access to the MAINTENANCE menu the password can be changed. The default password for the maintenance menu is 000118. The parameter involved is **SG39**. The password is a 6-digit number.

### 5. Setpoint settings

The cold aisle setpoint is set with the following parameter.

Scr.	Par.	Description	Default	Special value	Range	UOM
S03	1	Temperature/Cooling setpoint	23.0		-20.0 - 60.0	°C

### 6. Setpoint regulation type

The regulation type is set default as Proportional + Integral. This is the most accurate and responsive way of managing the setpoint (S03).

7. *Control of the cold aisle temperature*

The control of the Cold Aisle temperature is as follows. The compressor shall work with a signal from the controller to maintain the setpoint (S03). The differential range within which the compressor shall operate from 0 to 100% is set at a default value of 3°C (R05-1). The dead zone is set at a default value of 0,5°C (R05-3). These default settings results in the compressor starting at setpoint +0.5 °C and working at 100% of its capacity a temperature setpoint of +3.5°C.

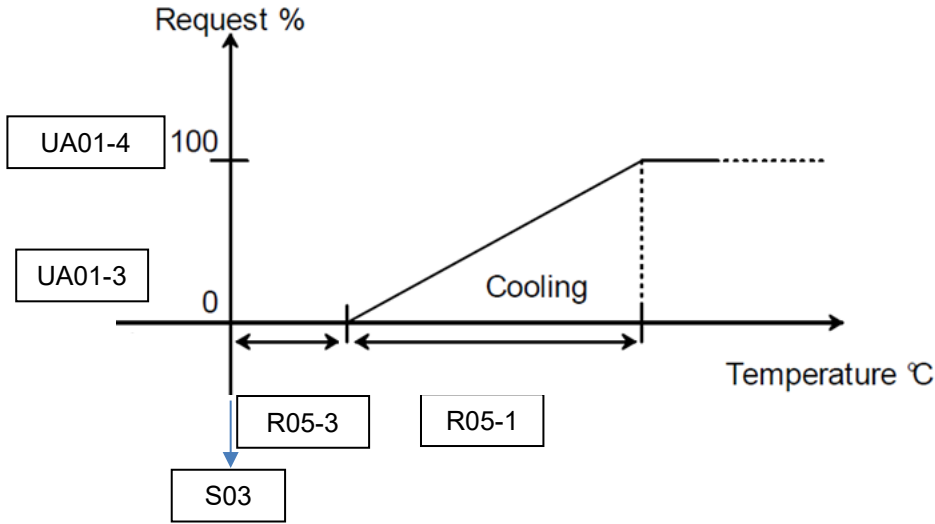

8. *Control of the hot aisle temperature*

The control of the Hot Aisle temperature is as follows. The fans shall work with Modbus signal from the controller to maintain the setpoint (S08). The differential range within which the fans shall operate from 45%(CF01-1) to 100% (CF01-2) is set at a default value of 3°C (R45-3). These default settings results in the fans starting at a minimum fan speed at a Delta T of 10°C. With the differential set at 3°C the fan speed shall increase to 100% when the Delta T reaches 13°C.

Scr.	Par.	Description	Default	Special value	Range	UOM
S08	3	Setpoint DT or Inlet air temperature	30	10	0.0 - 99.9	°C
R45	3	DT or Inlet air temperature control differential	3.0	3.0	0.0 - 99.9	°C

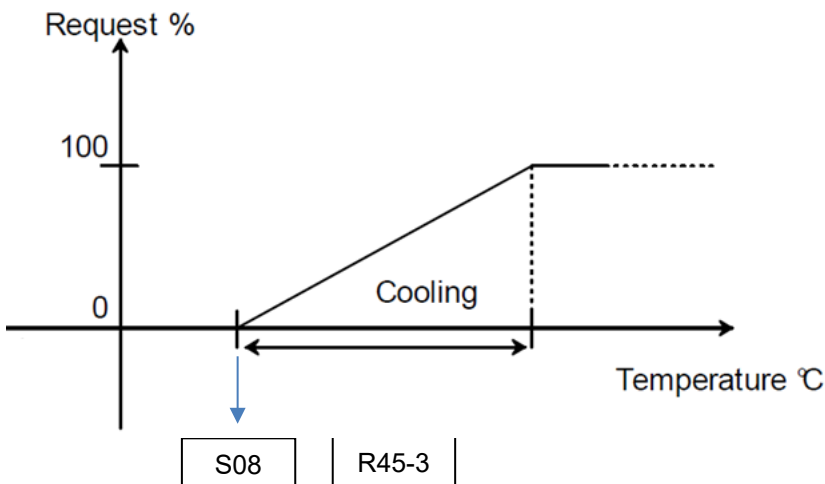

## 2. Monitoring & Control

The cooler is equipped with digital inputs & outputs, a remote ON/OFF connection, unit status, serial connections (pLAN) and (optional) BMS connection (pCOWeb). The location of these remote monitoring & control possibilities is at the rear of the cooler. Please consult the electrical drawing & parameter list supplied with the cooler for the specifics of your cooler. Configuration of the above is done in the MAINTENANCE MENU.

### 1. How to configure the Digital Input (1x)?

A digital input can be used to connect an additional sensor e.g., a Fire-Smoke or Water Rope sensor. The digital input works as a dry contact. A digital input can be programmed with the input logic Normally Open or Normally Closed. A description can be entered that will be displayed once the alarm is activated. The digital input can be configured with parameter **AS38**. For further details on the configuration, we refer to the software manual (6.4 - CONFIGURABLE ALARM INPUT). The alarm code for this Alarm is AL068.

The following masks can be found in the Maintenance menu -> alarm configuration.

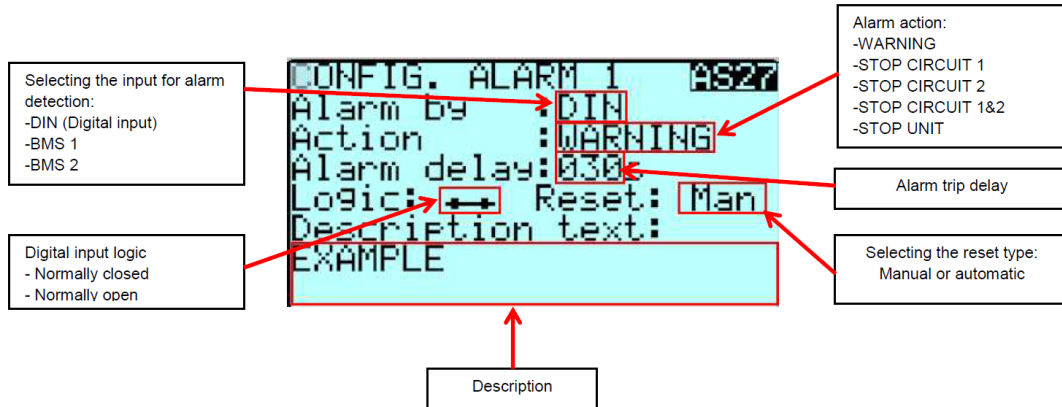

### 2. How to configure Digital Outputs (5x)?

It is possible to hard-wire up to a maximum of 5 digital outputs. Each alarm generated by the cooler can be configured to send a signal through one of the digital output connections. Please refer to the electrical drawing supplied with the cooler for the wiring diagram.

The digital outputs work as a dry contact. Note: Digital outputs 3,4 and 5 use the same common contact (C11), these are not electrically isolated from each other!

The digital outputs can be configured with parameters **AS32 – AS36**. For configuration we refer to the software manual (6.3 - CONFIGURABLE ALARM OUTPUTS).

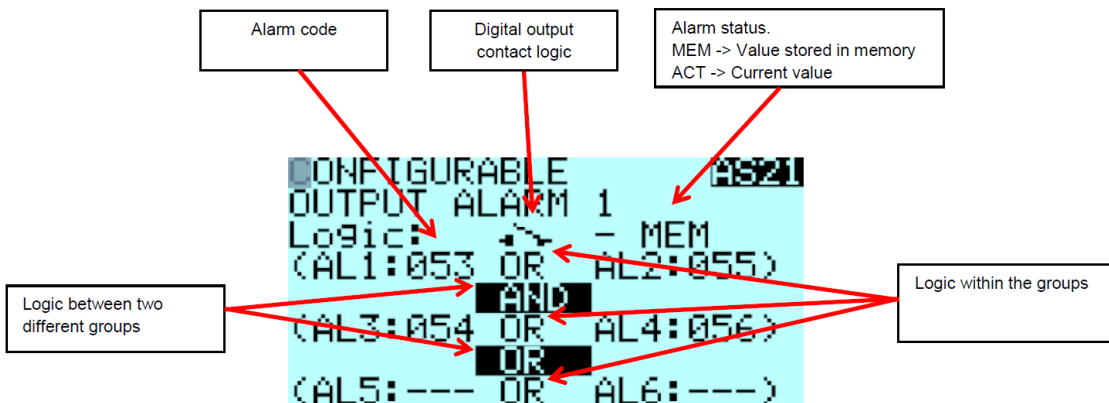

As an example, a High Temperature alarm can be configured. From the alarm list in the Software Manual (9 - ALARM LIST) we can see that this alarm is connected to AL071. We then need to connect AL1 to 071 to have a High Temperature alarm on the Digital output that is being configured. When desired an AND/OR logic with additional alarms can be configured as well.



To configure the High Temperature threshold, we need parameter **AS45**. Here the temperature sensor can be selected (inlet is hot aisle; outlet refers to cold aisle). The setpoint when the alarm is activated can be set, as well as a differential and a delay if requested.

### 3. How to configure the pLAN network settings?

The configuration of the pLAN network must be done on the display. Please refer to the software manual (7 - LAN NETWORK CONFIGURATION) to configure the pLAN. Please also refer to the electrical drawing for the specifics of the hard wiring between the units. The last cooler in the pLAN must be terminated with a 120Ω resistor on both ends of the RS485 bus.

Both the controller and the display must have a corresponding address for coolers to communicate with each other. Once the pLAN has been configured, the rotation and/or external communication preferences can be set. If one of the coolers in the pLAN is switched off or in alarm the remaining coolers in the pLAN shall continue to operate. The cooler with address 1 shall be named the master and the other coolers will function as slaves. Even when the Master cooler is down, the remaining coolers will keep on working with the latest known setpoints.

### 4. How to configure the BMS network settings?

For the external communication the unit is standardly equipped with a serial RS485 BMS module. For the configuration of the BMS module please refer to the software manual 3.5 – CONFIGURATION OF BMS AND WIRING RULES. Please refer to the electrical drawing for the specifics of the hard wiring between the units. Both outer ends of the RS485 bus must be terminated with a 120Ω resistor.

With parameter **UC00** the configuration of the BMS 1 can be done. In case of the standard (serial) communication the unit shall display MODBUS SLAVE 485.

In case of the optional pCOWeb communication card, the unit shall display PCOWEB / PCONET. Further configuration of the pCOWeb can be done by a direct connection to the cooler with a RJ45 cross connect cable.

BMS2 is not available and therefore not relevant for Nexpan coolers.

In the below picture an example is given of the terminal block for all customer connections. Please refer to the electrical diagram for the exact designation of each terminal to the respective function.

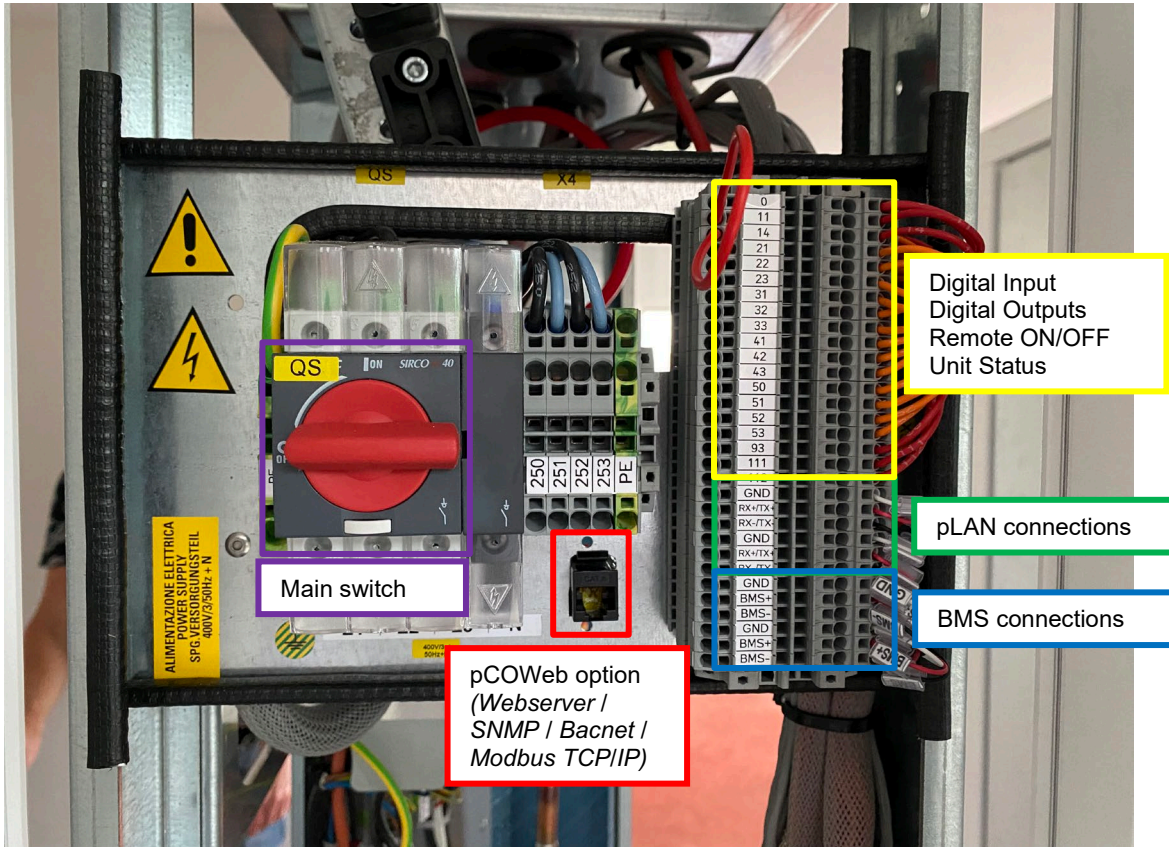

### 5. Start-up of the unit

To switch on the unit the main switch must be activated. For the start-up of the unit please consult the User Manual (6 - Start-up) and the Software Manual (4.1 - Switching the unit ON/OFF).

### 6. How to configure the remote ON/OFF of the cooler?

A hard-wired remote ON/OFF connection can be wired to contact 11-14 from the above terminal block. For the exact configuration please consult the Software Manual (4.1 – SWITCHING THE UNIT ON-OFF). The wiring connection may differ from unit to unit. Please consult the electrical wiring diagram of the cooler for more information.

To configure the remote ON/OFF, please find below the relevant parameters in the

Scr.	Par.	Description	Default	Special value	Range	UOM
FI01	1	PCO - Enable forcing digital input 1	0		0 = No 1 = Yes	
FI01	2	PCO - Forced value digital input 1	0		0 = N.C. 1 = N.O.	

### 7. How to configure coolers to work in rotation mode?

With parameters **SG01 – SG03** the rotation of the coolers can be programmed. If the coolers need to be forced from STANDBY to ON than this shall be configured with **SG10**.

Please refer to the Software Manual (7.7 LAN NETWORK CONFIGURATION) for a detailed description of this functionality.

### 3. Components

#### *Float Switch*

A float switch is placed in the condensate tray. The condensate tray is positioned underneath the evaporator. The condensate tray will collect any condensate when it occurs. The float switch is an extra security feature that will trigger an alarm when the water in the tray reaches a certain level. This may indicate a blocked condensate discharge and/or excessive condensation.

The configuration of this alarm is done with parameter **AS41**. The digital input used for this functionality is the Flooding Alarm. The associated alarm is the Flooding Alarm AL066.

Scr.	Par.	Description	Default	Special value	Range	UOM
AS41	1	Enable flooding alarm	1		0 = No 1 = Yes	
AS41	2	Flooding alarm logic	0		0 = N.C. 1 = N.O.	
AS41	3	Flooding alarm switch off unit	0		0 = No 1 = Yes	
AS41	4	Flooding alarm delay on start	0		0 - 999	Seconds
AS41	5	Flooding alarm delay on running	0		0 - 999	Seconds
AS42	1	Flooding alarm reset type	1		0 = Automatic 1 = Manual 2 = Manual after number of trials	
AS42	2	Flooding alarm reset delay	10		0 - 999	Seconds
AS42	3	Flooding alarm time monitoring	30		0 - 999	Minutes
AS42	4	Flooding alarm number of trials	5		0 - 99	Nr

#### *Fans*

The fans for all units are of type EC (Electronically Commutated). They are all hot swappable meaning they can be replaced during the operation of the cooler. A built-in security measure is that when the microprocessor fails, the fans will continue to run ensuring an uninterrupted cooling process. An alarm is generated when a fan-unit is down.

#### *Temperature sensors*

There are 2 temperature sensors located at the front (cold aisle, referred to as outlet sensors) and 2 temperature sensors at the rear (hot aisle, referred to as inlet sensors) of the unit. These are evenly distributed over the height of the cooler. The temperature values are used as input values for the controller to maintain the setpoints at both the cold & hot aisle. The input temperature values can be set as average or max. (parameter R04-5/ default = 0 (average)).

Scr.	Par.	Description	Default	Special value	Range	UOM
AS45	1	Enable high temperature alarm 1	1		0 = No 1 = Yes	
AS45	2	High temperature alarm 1 select probe	0		0 = Inlet 1 = Outlet	
AS45	3	High temperature alarm 1 setpoint	30.0		-999.9 - 999.9	°C
AS45	4	High temperature alarm 1 differential	3.0		0.0 - 99.9	°C
AS45	5	High temperature alarm 1 delay on start	0		0 - 999	Seconds
AS45	6	High temperature alarm 1 delay on running	600		0 - 999	Seconds
AS46	1	High temperature alarm 1 reset type	1		0 = Automatic 1 = Manual 2 = Manual after number of trials	
AS46	2	High temperature alarm 1 reset delay	30		0 - 999	Seconds
AS46	3	High temperature alarm 1 time monitoring	30		0 - 999	Minutes
AS46	4	High temperature alarm 1 number of trials	5		0 - 99	Nr



#### *Filters and differential pressure switch (optional)*

The filter set is mounted in the rear door. Once the rear door is closed and locked, a seal ensures an airtight fixation of the door to the cooler frame. This in turn ensures that the return air flow must pass through the filter and eliminates the chance of by-pass airflows.

When the option of the filter (class G4) is selected, a differential pressure switch is included in the unit. This switch is set at a factory default differential pressure setpoint. Once this threshold is reached, an alarm shall be generated indicating a clogged filter that needs replacement.

#### *Condensate pump (optional)*

A condensate pump is placed at the rear of the unit. It consists of a pump and a float switch chamber. The float switch shall activate the pump once water (condensate) enters this chamber. If the pump is unable to keep up with the flow rate of the water (e.g., clogged hose, broken pump, excessive amount of condensate) the float switch in the condensate tray will trigger the Flooding Alarm AL066.

#### *Compressor*

On **DX** units only primary brand scroll compressors in special execution for inverter application motor, are installed. Scroll compressor represent for Row-Based cooling units the best solution in terms of efficiency and reliability. The internal compression ratio is very close to the typical operating condition of Row-Based cooling, giving the maximum in terms of COPs (Coefficient of Performance) and the perfect balanced pressures at start up gives big advantages to the e\_motor in terms of reliability, mainly in this application, where frequent start up may be possible. All motors are thermally protected with an internal sensors chain: in case of overload this sensor opens without giving contacts to the connection box.

#### **Cooling components**

- Molecular mesh activated-alumina filter dryer.
- Flow indicator with humidity indicator (indications are provided directly on the sight glass).
- High- and low-pressure switches.
- Schrader valves for checks and/or maintenance.

Cooling Circuit

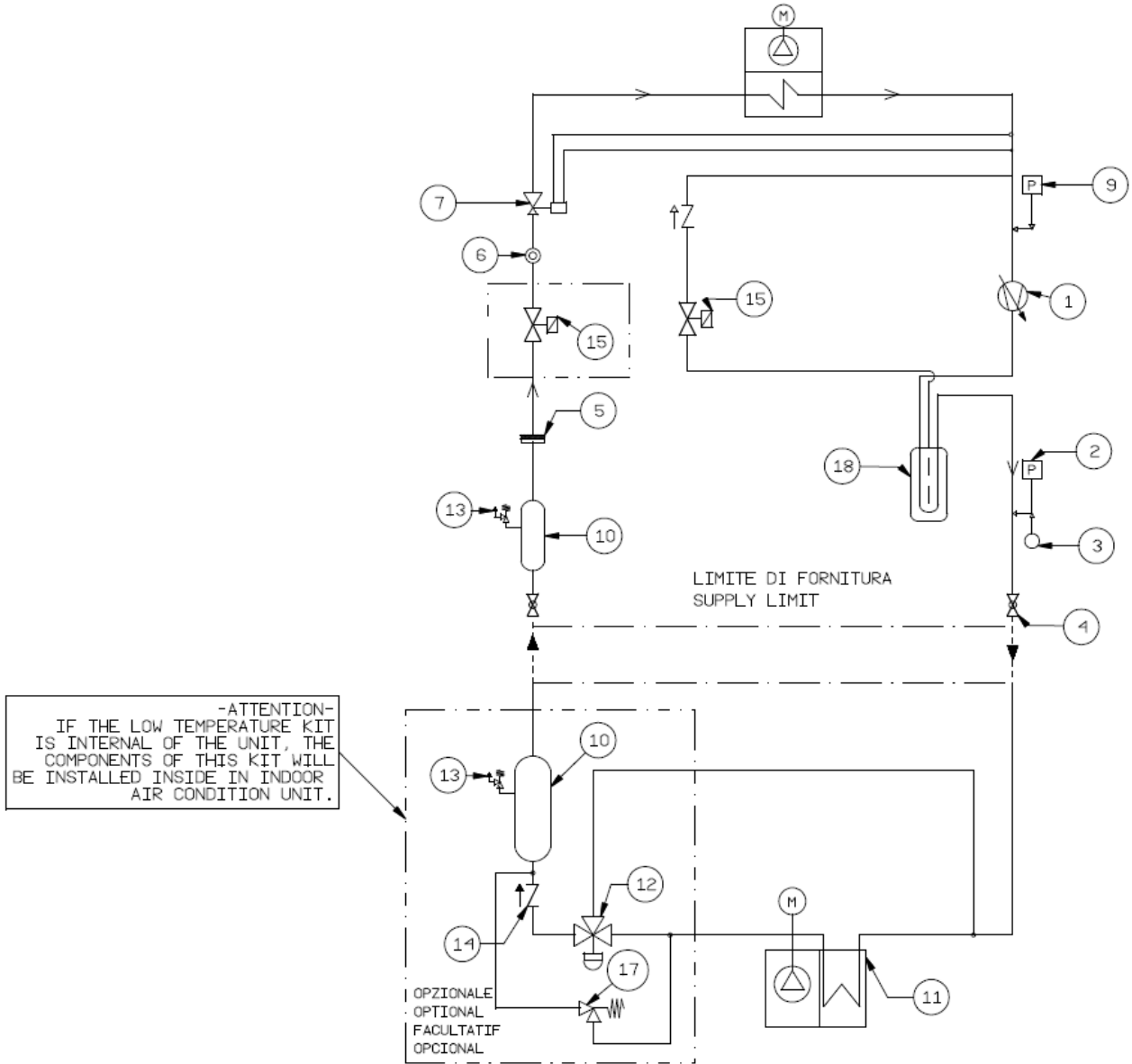

Ref.	Description	Ref.	Description
1	Inverter driven compressor	10	Liquid receiver
2	HP Pressure switch	11	Condenser
3	Pressure probe (opt.)	12	Flooding valve
4	Ball valve	13	Safety valve
5	Refrigerant filter	14	Check valve
6	Sight glass	15	Solenoid valve – included from model 0200
7	Thermostatic valve	16	Oil solenoid valve
8	Evaporator	17	Bypass valve - Long distance kit
9	LP pressure switch	18	Oil separator

## 4. Alarms

A list of alarms is available which can be used to monitor & control the cooler. In this document we shall only describe the applicable alarms for the specific application of Nexpan row-based coolers. For a detailed description we would like to refer to the software manual. Chapter 6 – ALARMS describes the use and configuration of the alarms. (Use the printed parameter list that comes with the unit for the actual parameter referencing).

In general, alarms can be connected to a level of severity. There are 3 levels being Warning, Not Serious and Serious. The action that should follow when a certain alarm occurs can also be configured (e.g. switching OFF the unit).

The alarm history can be consulted via the display. A maximum of 500 alarms can be stored. For each alarm which is memorized the following information is stored: Date, Time, Alarm Code, and a brief description of the alarm.

For diagnose purposes we strongly recommend not to delete any alarm history.

The alarms can also be programmed with a contact logic (Normally Open or Normally Closed).

To reset an alarm this can be programmed to be MANUAL, AUTOMATIC or MANUAL AFTER N ATTEMPTS. For more information, please consult the software manual (6.6 ALARM RESET).

ALARM LIST DX10/DX20						
Alarm code	Description	Severity level (Default)	Default value	default Unit behavior	Alarm reset	Remark (parameter)
AL001	Warning alarm	Not serious		Alarm	manual	
AL002	Not serious alarm	Not serious		Alarm	manual	
AL003	Serious alarm	Serious		Alarm	manual	
AL 010	Clock card alarm	Not serious		Alarm	manual	
AL 011	pLAN disconnect	Not serious		Alarm	manual	
AL 012	BMS 1 offline	Not serious		Alarm	manual	
AL 014	Inlet temperature probe 1 fault (backside of unit)	Serious		Alarm	manual	
AL 015	Inlet temperature probe 2 fault (backside of unit)	Serious		Alarm	manual	
AL 017	Outlet temperature probe 1 fault (frontside of unit)	Serious		Alarm	manual	
AL 018	Outlet temperature probe 2 fault frontside of unit)	Serious		Alarm	manual	
AL 048	Dirty filter Alarm	Not serious	350Pa (AA06-2)	Alarm	manual after 5 times of trails	30s delay and 30 minutes monitoring (AA07-2, AA07-3)
AL 049	Thermal fan Alarm	Serious		Alarm	manual after 5 times of trails	10s delay and 30 minutes monitoring (AD05-2, AD05-3)
AL 050	Power supply Alarm	Serious		Alarm	manual after 5 times of trails	30s delay and 30 minutes monitoring (AD07)
AL 066	Flooding Alarm (Float Switch condensate tray)	Serious		Alarm	manual	(AS36)

<b>AL 068</b>	Input configurable alarm	configurable		configurable	configurable	DI input (AS33)
<b>AL 071</b>	High temperature Alarm 1 (triggers on back side(inlet) )	Serious	30 degrees and 3 degrees differential	Alarm	manual	(AS45 and AS46)
<b>AL 279</b>	Alarm user fan 1	Serious		Alarm	manual	If 3 fans fail than unit will switch off (DX10)
<b>AL 280</b>	Alarm user fan 2	Serious		Alarm	manual	If 3 fans fail than unit will switch off (DX10)
<b>AL 281</b>	Alarm user fan 3	Serious		Alarm	manual	If 3 fans fail than unit will switch off (DX10)
<b>AL 282</b>	Alarm user fan 4	Serious		Alarm	manual	If 5 fans fail than unit will switch off (DX20)
<b>AL 283</b>	Alarm user fan 5	Serious		Alarm	manual	If 5 fans fail than unit will switch off (DX20)

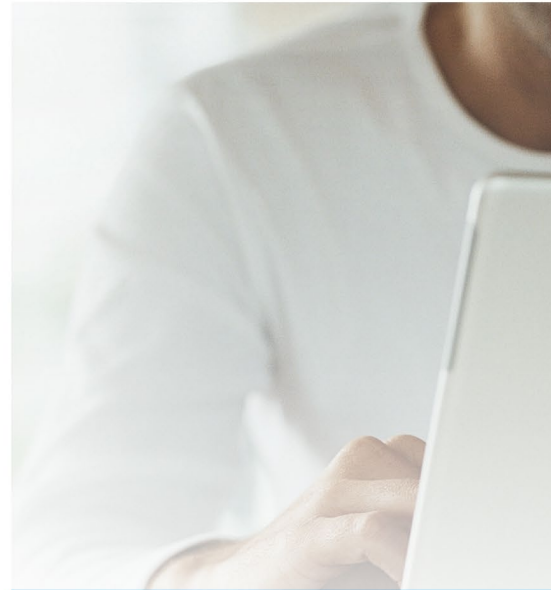

## FOLLOW US ON

 [minkels.com](http://minkels.com)

 [youtube.com/c/minkelshq](https://youtube.com/c/minkelshq)

 [twitter.com/minkels\\_hq](https://twitter.com/minkels_hq)

 [facebook.com/minkels](https://facebook.com/minkels)

 [linkedin.com/company/minkels](https://linkedin.com/company/minkels)



### MINKELS HEADQUARTERS & INTERNATIONAL

Eisenhowerweg 12

P.O. Box 28

5460 AA Veghel

t. +31 (0)413 311 100

[info@minkels.com](mailto:info@minkels.com)